

AIR-RITE MANUFACTURING, LLC

AHU CURBS

AIR-RITE MANUFACTURING

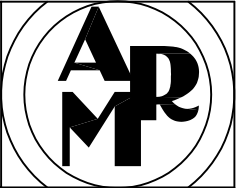

SUBMITTAL/FABRICATION DETAIL:
MODEL: AHU-1

COMBINATION
CURB

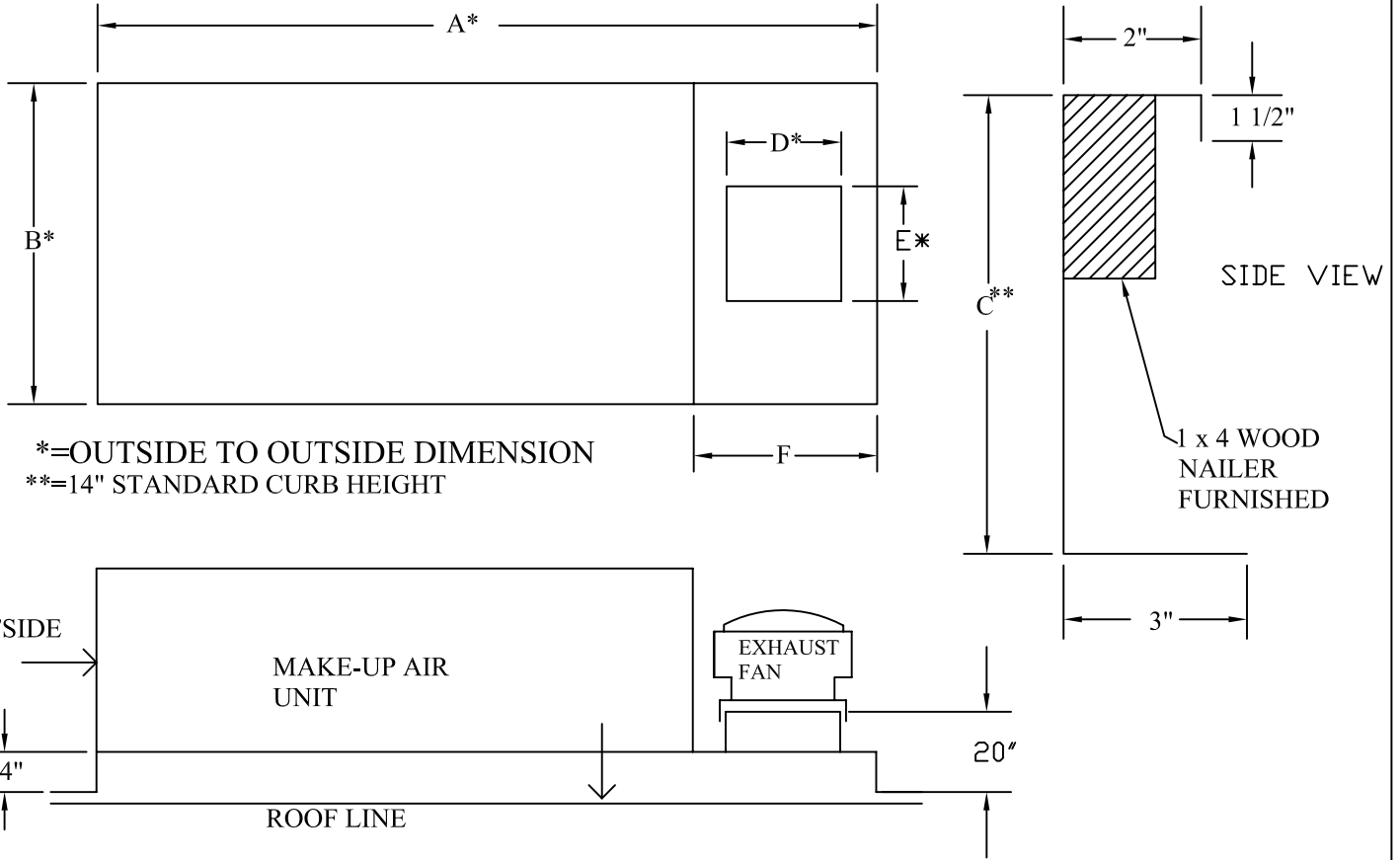

A= _____
B= _____
C= _____
D= _____
E= _____
F= _____
G= _____
H= _____

Standard Construction

- 18 Gauge sheet metal with welded corners.
- 1 x 4 wood nailer strip.

Optional Construction

- 20 ga. sound cover over compressor section of curb.
- Rectangular curbs.
- Height additions.
- Pitched curbs (specify pitch when ordering).
- Bolted corners for KD shipping.
- Burgular bars.
- Foam mounting gasket.
- Accoustic liner

Union "Blue Label" Made.

PROJECT NAME:	
ENGINEER:	
TAG #:	
CONTRACTOR:	
SUBMITTED BY:	

PAGE: AHU-1

AIR-RITE MANUFACTURING

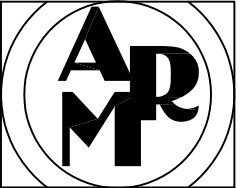

SUBMITTAL/FABRICATION DETAIL:
MODEL: AHU-1B

COMBINATION
CURB

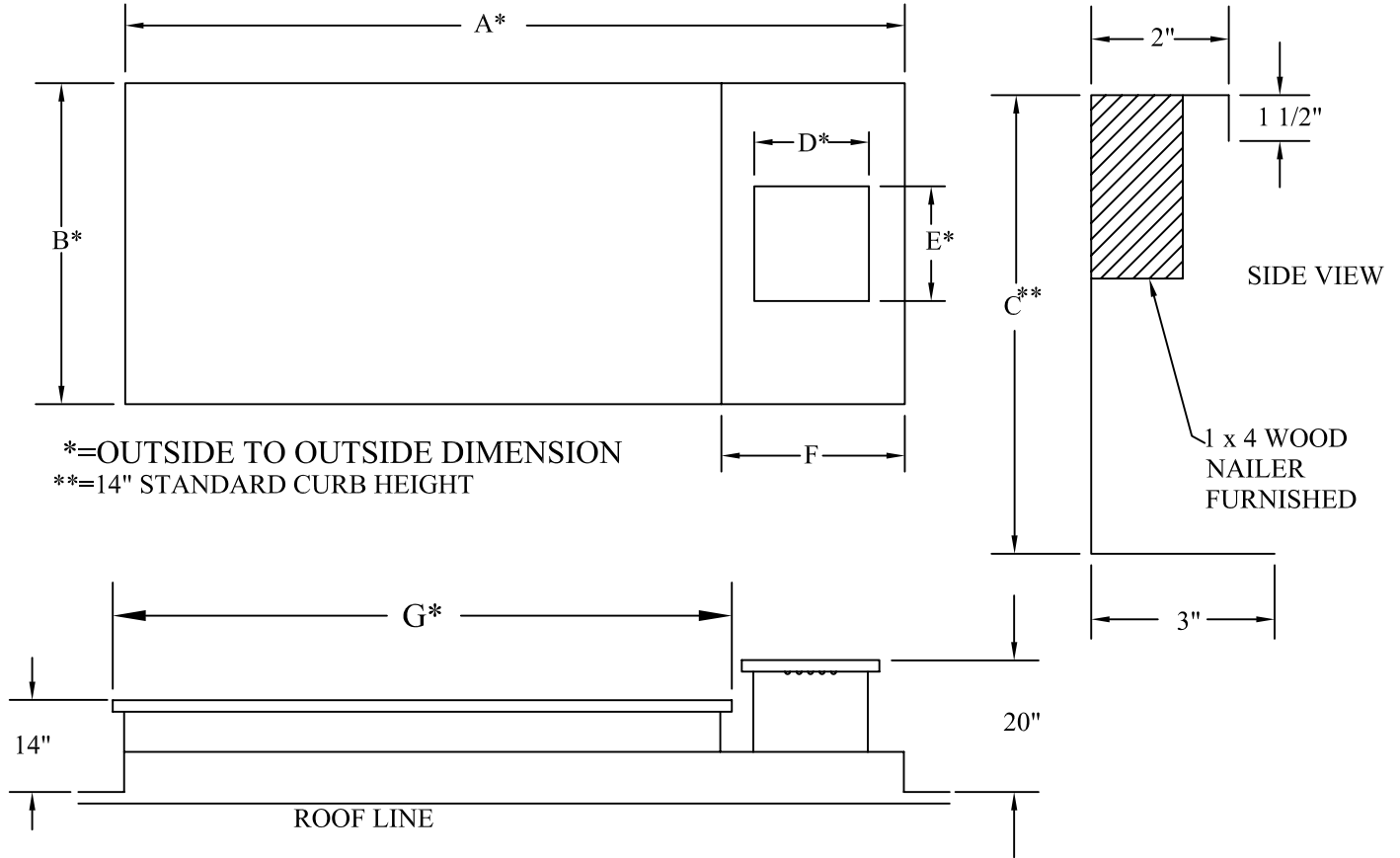

A= _____
B= _____
C= _____
D= _____
E= _____
F= _____
G= _____
H= _____

Standard Construction

- 18 Gauge sheet metal with welded corners.
- 1 x 4 wood nailer strip.

Optional Construction

- 20 ga. sound cover over compressor section of curb.
- Rectangular curbs.
- Height additions.
- Pitched curbs (specify pitch when ordering).
- Bolted corners for KD shipping.
- Burgular bars.
- Foam mounting gasket.
- Accoustic liner

Union "Blue Label" Made.

PROJECT NAME:	
ENGINEER:	
TAG #:	
CONTRACTOR:	
SUBMITTED BY:	

PAGE: AHU-1B

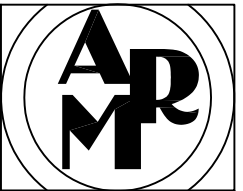

SUBMITTAL/FABRICATION DETAIL MODEL: AHU-2

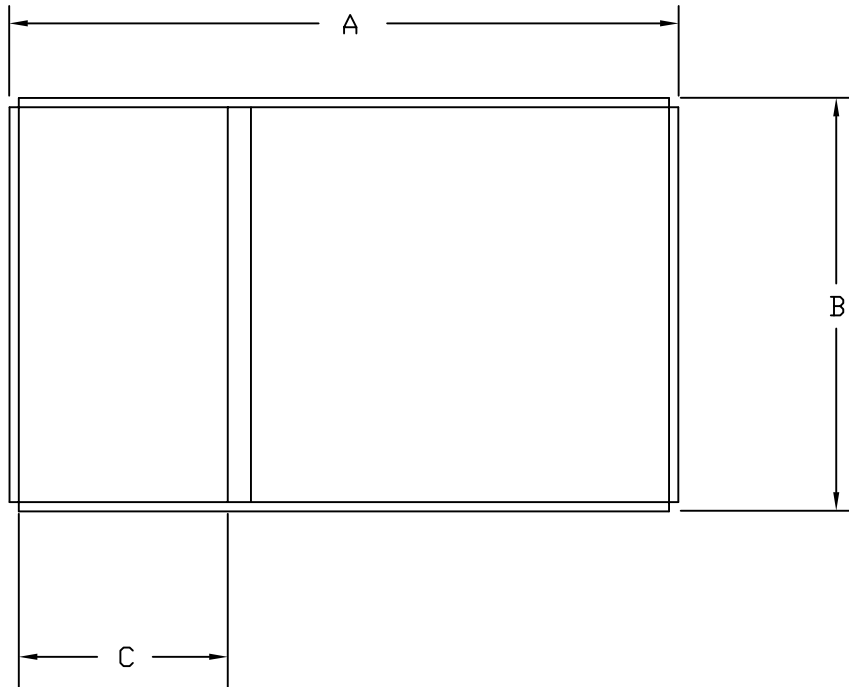

*=OUTSIDE TO OUTSIDE DIMENSION
**14" STANDARD CURB HEIGHT

A = _____
B = _____
C = _____

Standard Construction

- 18 Gauge sheet metal with welded corners.
- 1 x 4 wood nailer strip.

Optional Construction

- 20 ga. sound cover over compressor section of curb.
- Rectangular curbs.
- Height additions.
- Pitched curbs (specify pitch when ordering).
- Bolted corners for KD shipping.
- Burgular bars.
- Foam mounting gasket.
- Accoustic liner

Union "Blue Label" Made.

PROJECT NAME:
W/O #:
TAG #:
CONTRACTOR:
SUBMITTED BY:

PAGE: AHU-2

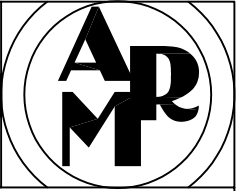

SUBMITTAL/FABRICATION DETAIL: STANDARD CURB MODEL: AHU-3

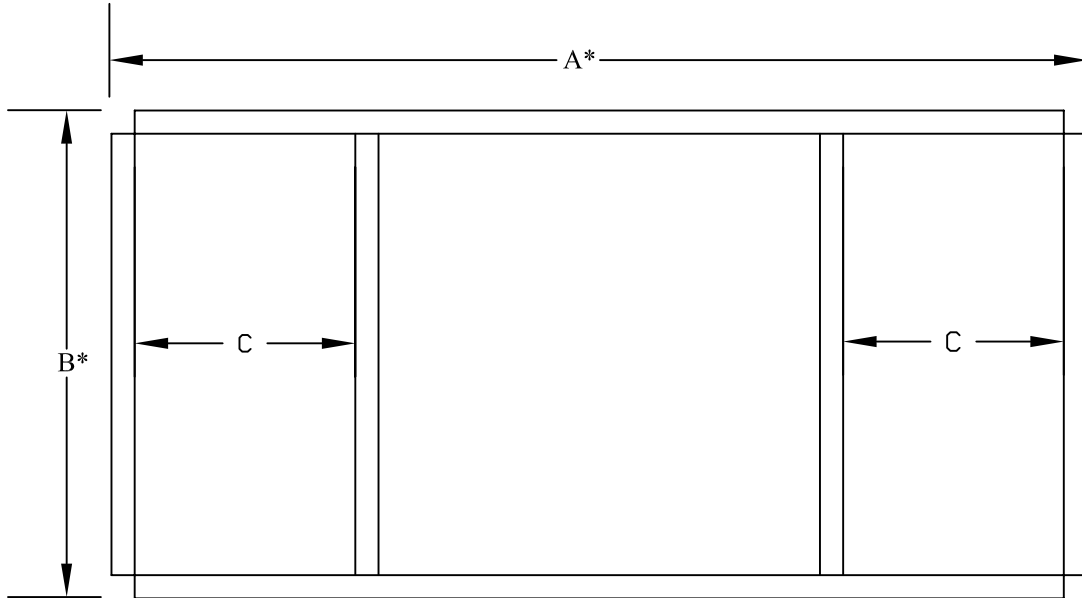

*=OUTSIDE TO OUTSIDE DIMENSION

- A= _____
- B= _____
- C= _____
- D= _____
- E= _____
- F= _____
- G= _____
- H= _____

HEIGHT: _____

MATERIAL: _____

Standard Construction

- 18 Gauge sheet metal with welded corners.
- 1 x 4 wood nailer strip.

Optional Construction

- 20 ga. sound cover over compressor section of curb.
- Rectangular curbs.
- Height additions.
- Pitched curbs (specify pitch when ordering).
- Bolted corners for KD shipping.
- Burgular bars.
- Foam mounting gasket.
- Accoustic liner

Union "Blue Label" Made.

PROJECT NAME:
W/O #:
TAG #:
CONTRACTOR:
SUBMITTED BY:

PAGE: AHU-3

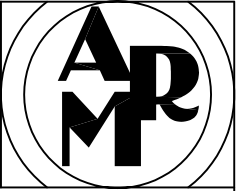

MODEL: MAU / AHU ROOF CURBS

PLEASE CONTACT THE FACTORY FOR QUOTES AND PRICING ON ALL AHU / MAU CURB MODELS.

PRICING FROM FACTORY IS BASED UPON 18 GAUGE GALVANIZED SHEET METAL CONSTRUCTION AND THE STANDARD HEIGHT OF 14", UNLESS OTHERWISE NOTED ON THE QUOTE.

THE PRICE QUOTE IS BASED UPON AIR-RITE MANUFACTURING STANDARD LEAD TIME OF 10 - 12 WORKING DAYS.

AHU / MAU OPTIONAL CONSTRUCTION PRICING

PLEASE ADD THE FOLLOWING TO YOUR QUOTE FOR ANY AND ALL CHANGES FROM OUR STANDARD QUOTE:

16 GAUGE GALVANIZED STEEL CONSTRUCTION ADD:		35%
ALUMINUM CONSTRUCTION ADD:		40%
NON-STANDARD HEIGHT ADD:		
	16"	30%
	20"	40%
	24"	50%
HEIGHTS TALLER THAN 24"		CONSULT FACTORY
PITCHED CURB ADD:		
	0" THRU 2" IN 12"	30%
	3" THRU 4" IN 12"	45%
	5" THRU 6" IN 12"	60%
	7" IN 12" AND OVER	CONSULT FACTORY
FOAM MOUNTING GASKET ADD:		5%