

**AIR-RITE MANUFACTURING, LLC**

PENTHOUSE

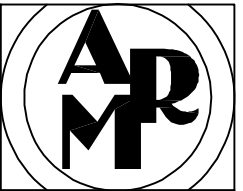

## SUBMITTAL/FABRICATION DETAIL

MODEL: LP-1      **FORMED LOUVERED PENTHOUSE**

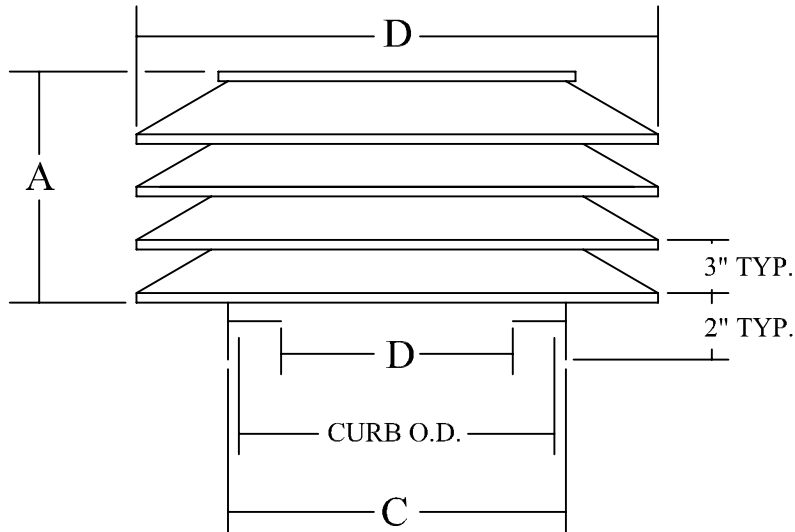

### STANDARD CONSTRUCTION

1. FRAME IS .063 5052-T5 FORMED ALUMINUM WELDED.
2. BLADES ARE .063 5052-T5 FORMED ALUMINUM WITH WELDED CORNERS.
3. TOP IS .063 FORMED ALUMINUM WITH 1" INSULATION.
4. 1/2" MESH BIRD SCREEN.
5. STANDARD FINISH - MILL

**\*\*BAKED ENAMEL AND ANODIZED FINISHES AVAILABLE.\*\***

QTY.	THROAT SIZE	ROWS

### (A) HEIGHT DIMENSION

- 2 ROW = 8"
- 3 ROW = 11"
- 4 ROW = 14"
- 6 ROW = 20"
- 8 ROW = 26"

### (B) DIMENSION

THROAT I.D. + 1 1/4"

### (C) CURB CAP DIMENSION

THROAT I.D. + 5 1/2"

### (D) DIMENSION

THROAT I.D. + 12 1/2"

### CURB O.D.

THROAT I.D. + 4"

MATERIAL: GALVANIZED

ALUMINUM

PAINT-LOC

NOTE: MINIMUM SIZE = 12" x 12"  
MAX. 1 PC. CONSTRUCTION = 48" x 48"

Union "Blue Label" Made.

PROJECT NAME:
W/O #:
TAG #:
CONTRACTOR:
SUBMITTED BY:

**PAGE: LP-1**

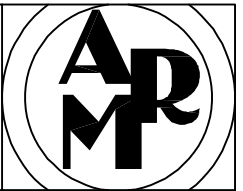

## SUBMITTAL/FABRICATION DETAIL: EXT. ALUM. LOUVERED PENTHOUSE MODEL: LPE-1

### STANDARD CONSTRUCTION

1. FRAME IS .125 6063-T5  
EXT. ALUM. WELDED.
2. BLADES ARE .094 6063-T5  
EXT. ALUM. WITH WELDED  
CORNERS. ALL OTHER  
FASTENERS ARE MECHANICAL  
TYPE.
3. TOP IS .063 FORMED ALUM.  
WITH 1" INSULATION.
4. SCREEN IS 1/2" 18 GA.  
FLATTENED EXPANDED METAL.
5. STANDARD FINISH - MILL

\*\*BAKED ENAMEL AND  
ANODIZED FINISHES  
AVAILABLE.

### (A) HEIGHT DIMENSION

- 2 ROW 8"
- 3 ROW 11"
- 4 ROW 14"
- 6 ROW 20"
- 8 ROW 26"

### (B) DIMENSION

THROAT I.D. + 1 1/4"

### (C) CURB CAP DIMENSION

THROAT I.D. + 5"

### (D) DIMENSION

THROAT I.D. + 12 1/2"

### CURB O.D.

THROAT I.D. + 4"

QTY.	SIZE	ROWS

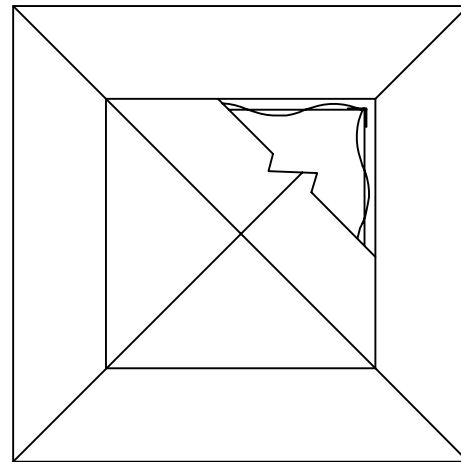
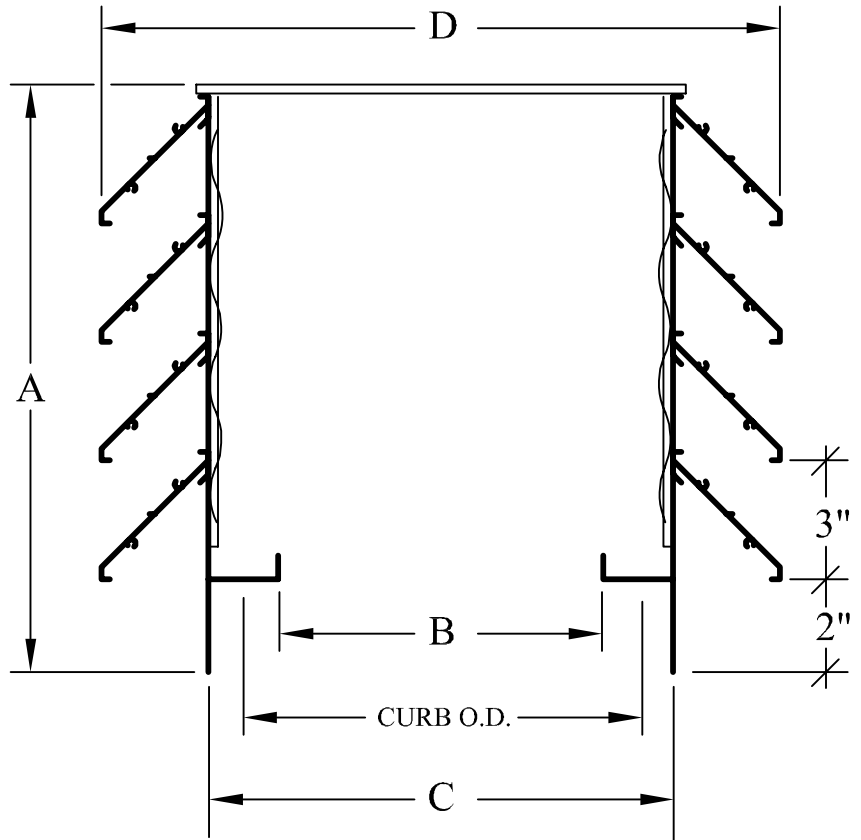

TOP VIEW

Union "Blue Label" Made.

### OPTIONAL CONSTRUCTION

- BOXED CORNERS
- MITERED CORNERS
- DRAINABLE BLADE (AVAILABLE FOR BOXED CORNER  
CONSTRUCTION ONLY.)

NOTE: MINIMUM SIZE = 12" x 12"  
MAXIMUM 1 PC. CONSTRUCTION = 48" x 48"

PROJECT NAME:
W/O #:
TAG #:
CONTRACTOR:
SUBMITTED BY:

PAGE: LPE-1

# AIR-RITE MANUFACTURING

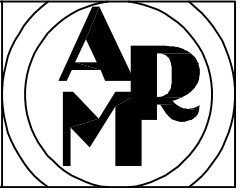

SPECIFICATION SHEET:

MODEL: LPE-1 (EXTRUDED ALUMINUM PENTHOUSE)

**LPE-1 LOUVERED INTAKE HOOD NOTES:**

**FACE VELOCITIES UP TO 600 FPM - FACE VELOCITIES BELOW 600 FPM CAN PROVIDE A LEVEL OF PROTECTION AGAINST THE INTAKE OR INTRODUCTION OF AIRBORN DEBRIS AND/OR MOISTURE INTO THE BUILDING.**

**FACE VELOCITIES OF 600 FPM TO 1000 FPM - THERE IS A POSSIBILITY THAT AIRBORNE DEBRIS AND/OR MOISTURE CAN BE CARRIED INTO THE BUILDING THROUGH THE HOOD. CARE MUST BE TAKEN IN THE INSTALLATION LOCATION OF THE UNIT IF AIRBORNE DEBRIS AND/OR MOISTURE IS A CONCERN.**

**FACE VELOCITIES ABOVE 1000 FPM - LPE LOUVERED INTAKE HOODS ARE NOT RECOMMENDED IF VELOCITIES FALL ABOVE 1000 FPM, UNLESS SPECIAL MEANS ARE TAKEN TO PREVENT THE INTRODUCTION OF AIRBORNE DEBRIS AND/OR MOISTURE INTO THE BUILDING. (SEE LPE-SSH)**

**\*\*\* VELOCITIES SHOWN ARE TO BE USED AS A GUIDE ONLY. FINAL INSTALLATION LOCATIONS, APPLICATIONS AND CONDITIONS WILL BE THE GOVERNING FACTORS. \*\*\***

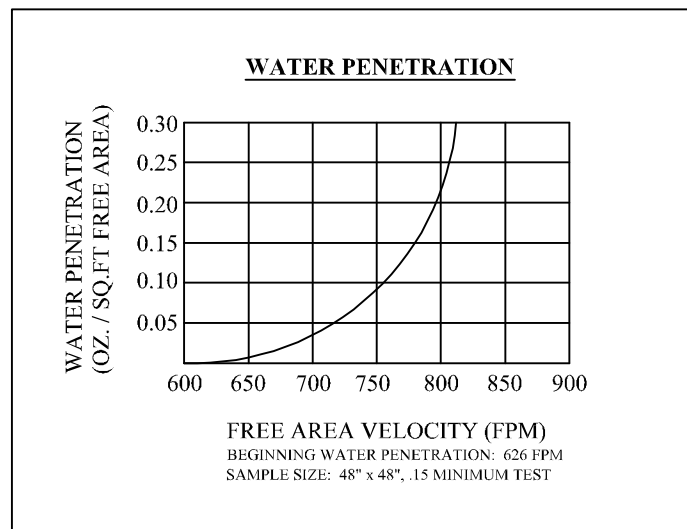
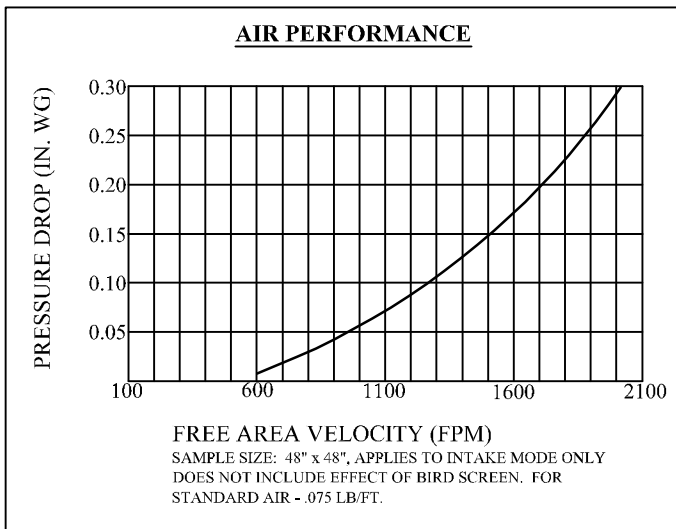

THROAT I.D. = REQUIRED THROAT INSIDE DIMENSIONS  
 THROAT SQ. FT. = REQUIRED THROAT SQUARE FOOT  
 ROW = NUMBER OF ROWS OF BLADES  
 A,B,C,D = DIMENSIONS TAKE FROM SUBMITTAL SHEET  
 CURB O.D. = OUTSIDE ROOF CURB DIMENSIONS  
 LPE-1 F.A. SQ. FT. = AMOUNT OF FREE AREA IN PENTHOUSE

RECTANGULAR THROAT PENTHOUSE CAN BE CALCULATED  
 USING EQUIVALENT SQ. FT. OR EQUAL THROAT TOTAL LENGTH

**FREE AREA PER LINEAL FT. OF DIMINUTION "C"**

2-ROW = .375 SQ. FT. PER LINEAL FT.  
 3-ROW = .563 SQ. FT. PER LINEAL FT.  
 4-ROW = .75 SQ. FT. PER LINEAL FT.

**EXAMPLE 12" x 12" I.D. THROAT 2-ROW TALL**

12" x 12" I.D. THROAT, DIMENSION C = 17 1/2"  
 17 1/2" x 4 SIDES = 70". DIVIDED BY 12" = 5.83 LINEAL FT.  
 5.83 LINEAL FT. x .375 = 2.19 SQ. FT. FREE AREA.

Union "Blue Label" Made.

PROJECT NAME:
ENGINEER:
TAG #:
CONTRACTOR:
SUBMITTED BY:

# LPE-1 Specifications

Air-Rite Mfg.

## Extruded Louvered Penthouse

### Intake Performance Data

Throat Size In.	No. of Tiers	Hood Size In.	LPE Height In.	Throat Area SF	(WG) Pressure Drop						
					Ducted						
					0.02	0.1	0.15	0.2	0.25	0.3	0.5
					Non-ducted						
					0.028	0.135	0.2	0.27	0.325	0.395	0.65
(CFM) Airflow											
12 x 12	2	24.75 x 24.75	7	1.17	325	725	880	1025	1150	1250	1620
12 x 14	2	24.75 x 26.75	7	1.35	360	820	1000	1150	1290	1390	1825
12 x 16	2	24.75 x 28.75	7	1.53	400	900	1105	1275	1430	1565	2020
12 x 18	2	24.75 x 30.75	7	1.71	440	985	1205	1390	1555	1700	2200
12 x 24	2	24.75 x 36.75	7	2.26	540	1200	1480	1710	1913	2100	2700
14 x 14	2	26.75 x 26.75	7	1.56	410	915	1120	1295	1445	1580	2045
14 x 16	2	26.75 x 28.75	7	1.77	450	1005	1230	1420	1590	1740	2245
14 x 18	2	26.75 x 30.75	7	1.98	490	1090	1330	1540	1720	1885	2435
14 x 24	2	26.75 x 36.75	7	2.6	595	1325	1620	1875	2090	2290	2960
14 x 30	2	26.75 x 42.75	7	3.23	855	1910	2340	2705	3025	3310	4275
16 x 16	2	28.75 x 28.75	7	2	491	1100	1345	1555	1735	1900	2455
16 x 18	2	28.75 x 30.75	7	2.24	530	1190	1455	1675	1875	2055	2650
16 x 24	2	28.75 x 36.75	7	2.95	640	1430	1750	2015	2250	2470	3190
16 x 30	3	28.75 x 42.75	10	3.33	930	2090	2555	2950	3300	3610	4660
16 x 32	3	28.75 x 44.75	10	3.89	980	2190	2680	3095	3460	3790	4890
18 x 18	2	30.75 x 30.75	7	2.5	570	1275	1565	1805	2020	2210	2855
18 x 24	2	30.75 x 36.75	7	3.3	680	1520	1860	2150	2400	2632	3400
18 x 30	3	30.75 x 42.75	10	4.09	1000	2245	2750	3175	3550	3885	5020
18 x 32	3	30.75 x 44.75	10	4.35	1050	2350	2880	3325	3715	4070	5255
18 x 36	3	30.75 x 48.75	10	4.88	1140	2560	3130	3615	4040	4425	5715
24 x 24	3	36.75 x 36.75	10	4.34	1035	2310	2830	3270	3655	4002	5165
24 x 30	3	36.75 x 42.75	10	5.38	1190	2665	3265	3770	4215	4615	5960
24 x 32	3	36.75 x 44.75	10	5.73	1240	2775	3400	3925	4390	4810	6210
24 x 36	4	36.75 x 48.75	13	6.42	1595	3565	4365	5040	5635	6170	7970
24 x 42	4	36.75 x 54.75	13	7.46	1780	3975	4870	5625	6290	6890	8895
24 x 48	4	36.75 x 60.75	13	8.5	1960	4375	5360	6190	6920	7580	9775
30 x 30	3	42.75 x 42.75	10	6.67	1355	3030	3710	4285	4790	5250	7035
30 x 32	3	42.75 x 44.75	10	7.1	1410	3145	3855	4450	4975	5450	7145
30 x 36	4	42.75 x 48.75	13	7.96	1830	4090	5010	5785	6465	7085	9115
30 x 42	4	42.75 x 54.75	13	9.25	2025	4525	5540	6400	7150	7835	11045
30 x 48	4	42.75 x 60.75	13	10.55	2210	4940	6050	6985	7810	8555	13825
30 x 54	5	42.75 x 66.75	16	11.84	2765	6185	7575	8745	9775	10710	16590
30 x 60	6	42.75 x 72.75	19	13.1	3320	7420	9085	10490	11730	12850	21570
32 x 32	3	44.75 x 44.75	10	7.56	1460	3260	3995	4610	5160	5650	7510
32 x 36	4	44.75 x 48.75	13	8.48	1905	4525	5210	6015	6725	7370	9690
32 x 42	4	44.75 x 54.75	13	9.85	2100	4690	5750	6635	7420	8125	10490
32 x 48	4	44.75 x 60.75	13	11.23	2285	5110	6260	7230	8080	8850	11430
32 x 54	5	44.75 x 66.74	16	12.6	2870	6415	7855	9074	10145	11110	14345
32 x 60	6	44.75 x 72.75	19	13.98	3450	7715	9450	10910	12200	13365	17250
32 x 72	7	44.75 x 84.75	22	16.73	4315	9650	11815	13644	15255	16710	21570

# LPE-1 Specifications

Air-Rite Mfg.

## Extruded Louvered Penthouse

### Intake Performance Data

Throat Size In.	No. of Tiers	Hood Size In.	LPE Height In.	Throat Area SF	(WG) Pressure Drop						
					Ducted						
					0.02	0.1	0.15	0.2	0.25	0.3	0.5
					Non-ducted						
					0.028	0.135	0.2	0.27	0.325	0.395	0.65
(CFM) Airflow											
36 x 36	4	48.75 x 48.75	13	9.5	2045	4565	5595	6460	7225	7910	10215
36 x 42	4	48.75 x 54.75	13	11.05	2240	5015	6140	7090	7925	8685	11210
36 x 48	5	48.75 x 60.75	16	12.6	3835	6340	7760	8960	10020	10975	14170
36 x 54	5	48.75 x 66.75	16	14.13	3065	6855	8395	9695	10840	11875	15330
36 x 60	6	48.75 x 72.75	19	15.67	3700	4275	10135	11705	13085	14335	18505
36 x 72	7	48.75 x 84.75	22	18.75	4635	10360	12690	14651	16380	17945	23165
42 x 42	5	54.75 x 54.75	16	12.84	2855	6385	7820	9030	10095	11060	14275
42 x 48	5	54.75 x 60.75	16	14.63	3100	6940	8500	9810	10970	12020	15515
42 x 54	5	54.75 x 66.75	16	16.42	3340	7470	9150	10565	11810	12940	16705
42 x 60	6	54.75 x 72.75	19	18.21	4050	9055	11090	12805	14320	15683	20245
42 x 72	7	54.75 x 84.75	22	21.8	5070	11340	13890	16040	17930	19645	25360
42 x 84	8	54.75 x 96.75	25	25.38	6160	13775	16870	19480	21780	23855	30800
48 x 48	5	60.75 x 60.75	16	16.67	3355	7505	9190	10610	11865	12995	16780
48 x 54	6	60.75 x 66.75	19	18.71	4090	9145	11200	12930	14455	15835	20445
48 x 60	6	60.75 x 72.75	19	20.75	4375	9780	11980	13830	15465	16940	21670
48 x 72	7	60.75 x 84.75	22	24.84	5475	12245	15000	17320	19360	21210	27380
48 x 84	8	60.75 x 96.75	25	28.92	6655	14880	18225	21040	23525	25770	33270
48 x 96	9	60.75 x 108.75	28	33	7900	17660	21630	24975	27924	30590	39490
54 x 54	6	66.75 x 66.75	19	21	4390	9820	12025	18885	15525	17005	21950
54 x 60	6	66.75 x 72.75	19	23.3	4680	10465	12820	14800	16550	18130	23405
54 x 72	7	66.75 x 84.75	22	27.88	5855	13095	46040	18520	20704	22680	29280
54 x 84	8	66.75 x 96.75	25	32.46	7115	15910	19485	22500	25155	27555	35575
54 x 96	9	66.75 x 108.75	28	37	8450	18890	23135	26715	29870	32720	42240
54 x 108	10	66.75 x 120.75	31	41.63	9850	22020	26970	31143	34820	38140	49240
60 x 60	7	72.75 x 72.75	22	25.84	5550	12410	15205	17555	19625	21500	27755
60 x 72	7	72.75 x 84.75	22	30.92	6220	13905	17030	19660	21985	24080	31090
60 x 84	8	72.75 x 96.75	25	36	7550	16885	20680	23875	26695	29240	37750
60 x 96	9	72.75 x 108.75	28	41	8965	20045	24550	28350	31695	34720	44825
60 x 108	10	72.75 x 120.75	31	46.17	10455	23375	28630	33060	36960	40490	52270
60 x 120	10	72.75 x 132.75	31	51.25	12655	28300	34670	40020	44745	49015	63280

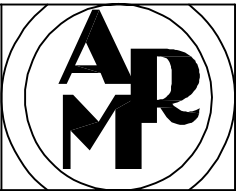

**MODEL: LP-1, LPE-1**

## STANDARD PENTHOUSE PRICING

EXTRUDED ALUMINUM PENTHOUSES (LPE-1)  
FORMED GALVANIZED PENTHOUSES (LP-1)

	12"	14"	16"	18"	20"	22"	24"	30"	36"	42"	48"
12"	500	530	548	588	630	678	728	764	792	826	844
14"	530	548	588	630	678	728	778	814	846	876	890
16"	548	588	610	646	692	738	790	832	876	918	936
18"	588	630	646	664	706	754	808	858	908	962	984
20"	630	678	692	706	732	778	814	880	944	1008	1028
22"	678	728	738	754	778	782	828	908	986	1066	1098
24"	728	778	788	808	814	828	836	926	1016	1116	1152
30"	764	814	832	858	880	908	926	934	1024	1134	1204
36"	792	846	876	908	944	988	1016	1024	1062	1206	1242
42"	826	876	918	962	1008	1066	1116	1134	1206	1224	1296
48"	844	890	936	984	1030	1098	1152	1204	1242	1296	1332
54"	864	930	994	1060	1124	1188	1254	1318	1384	1452	1512
60"	930	994	1060	1124	1188	1254	1322	1390	1462	1530	1584

**\*\*\*FOR LP-1 CONSTRUCTION DEDUCT: 10% \*\*\***

- ALL PRICES BASED ON TWO ROWS HIGH
- CONSULT FACTORY FOR SIZES NOT SHOWN

**OPTIONS:**

- 3 ROW ..... ADD 10%
- 4 ROW ..... ADD 35%
- 6 ROW ..... ADD 65%
- 8 ROW ..... ADD 85%

**BIRDSCREEN MULTIPLIERS:**

- 1/2" EXPANDED ALUMINUM - STANDARD
- ALUMINUM INSECT SCREEN - LIST x 1.10

**FINISHES:**

- MILL FINISH ..... STANDARD
- AIR DRY PRIMER ..... LIST x 1.40
- POWDER COAT ..... LIST x 1.50
- KYNAR FINISHES ..... LIST x 1.80
- ANODIZED FINISHES ... CONSULT FACTORY

**\*\*NOTE: PLEASE ALLOW AN ADDITIONAL 5 DAYS LEAD TIME FOR PAINTED OR ANODIZED FINISHES.\*\***

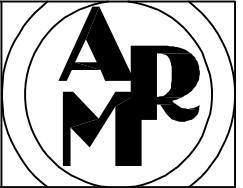

SUBMITTAL/FABRICATION DETAIL: LOUVERED PENTHOUSE STORM SHIELD  
 MODEL: LPE-SSH

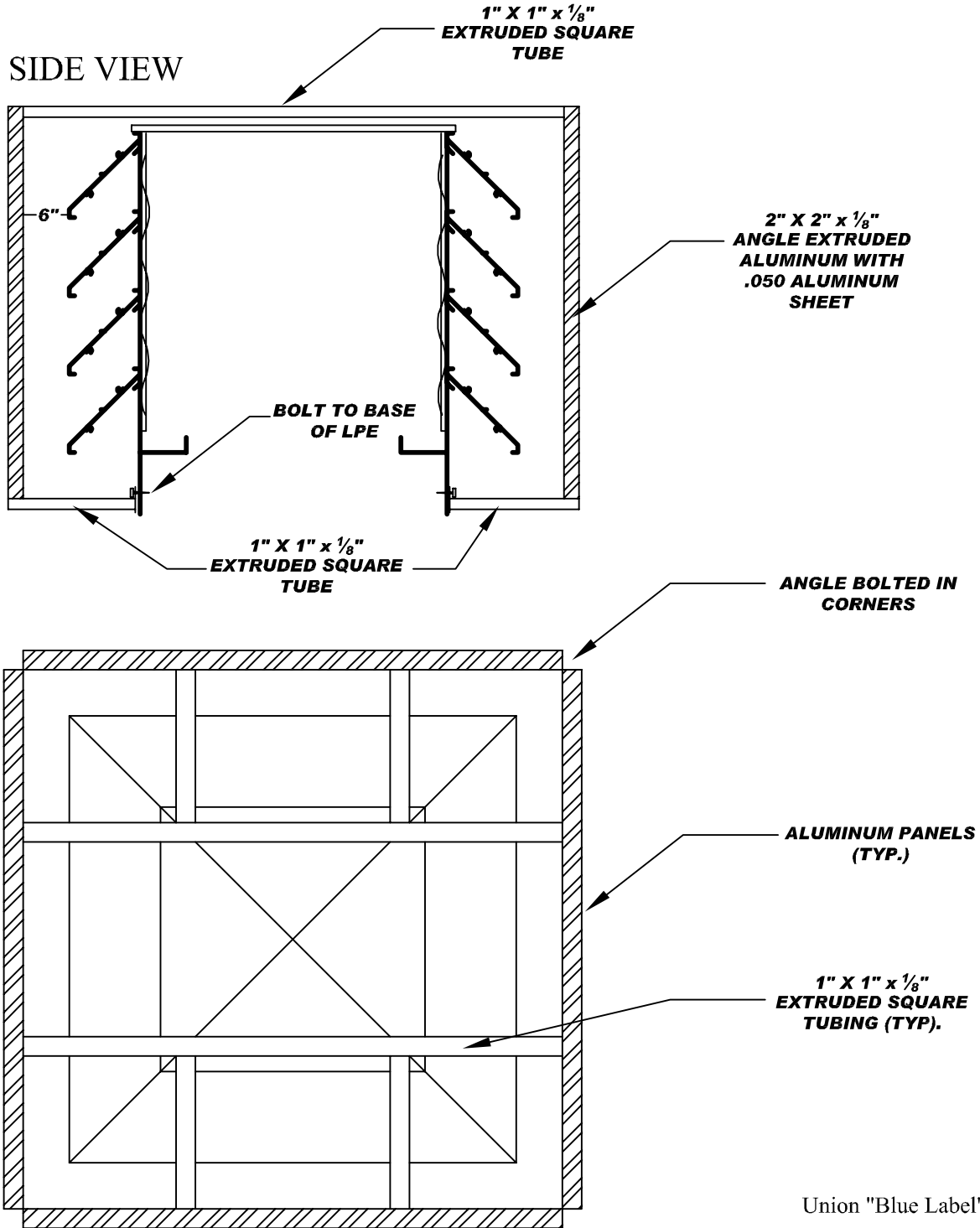

Union "Blue Label" Made.

PROJECT NAME:
W/O #:
TAG #:
CONTRACTOR:
SUBMITTED BY: